

## ACCESORIO MALEABLE GALVANIZADO

### UTILIZACIÓN

Uso en agua fría y agua caliente, aceite, aire, gas, vapor, etc.

### MATERIALES

Hierro fundido grado B-350-10 según norma UNE-EN-1562.

Fundición maleable de corazón negro (no descarbonada).

Min. Recubrimiento galvánico: 70 µm.

Pureza del Zn en masa: 98,05%.

Carga de rotura mínima: 350N/mm<sup>2</sup>.

### LÍMITES TÉCNICOS

Rango de temperaturas de trabajo: -20° a 300°C.

Presión de trabajo máxima -20 a 120°C: 25 bar (350psi).

Presión de trabajo máxima 120 a 180°C: 20 bar (300psi).

Presión de trabajo máxima 180 a 300°C: 16 bar (200psi).

En ACS la temperatura máxima de trabajo: 60°C.

### CARACTERÍSTICAS

Fabricado bajo norma UNE-EN-10242.

Roscas de unión según ISO 7/1 (DIN 2999/BS 21).

Diámetro nominal DN s/ ISO 6708.

Las dimensiones han sido fabricadas de acuerdo a las normas ISO 49, DIN 2950 y brida (321) EN-1092 PN6.

Producto para conducción de agua potable, según norma EN 10204:1994.

Fabricado para tubo DIN2440 y DIN2448.

Calidad GJMB-350-10.

Certificado de conformidad de producto emitido por la Generalitat de Cataluña.

Accesorio certificado ACS.

Accesorio certificado FM.



REF: CA\_022023\_REV1



Para prevenir roturas, accidentes o daños severos, NO USAR este producto fuera de los límites técnicos y sus aplicaciones.  
Las normas locales pueden regular el uso de este producto.



AQL PROTECCION

Carretera N-340 Km 1245, 3 Nave B-5 Polígono industrial El Pla 08750 Molins de Rei, Barcelona (España)  
Tel. (+34) 936800376 \* WhatsApp pedidos: 660781482 \* [www.aqlproteccion.com](http://www.aqlproteccion.com) \* [aql@aqlproteccion.com](mailto:aql@aqlproteccion.com)

ANBER

Avda. de las Flores, 13-15 P.E. El Molino 28970 Humanes de Madrid, Madrid (España)  
Tel. (+34) 916063711 \* WhatsApp pedidos: 649787619 \* [www.anber.es](http://www.anber.es) \* [anber@anber.es](mailto:anber@anber.es)

**001**

Curva 90° M/H

**002**

Curva 90° H/H

**003**

Curva 90° M/M

**040**

Curva 45° M/H

**041**

Curva 45° H/H

**085**

Curva puente H/H

**090**

Codo 90° H/H

**092**

Codo 90° M/H

**090R**

Codo 90° reducido H/H

**096**

Codo unión H/H asiento cónico

**098**

Codo unión M/H asiento cónico

**120**

Codo 45° H/H

**180**

Cruz 90° H

**221**

Codo 3 bocas H

**223**

Codo 4 bocas H

**130**

Te 90° igual H



REF: CA\_022023\_REV1



Para prevenir roturas, accidentes o daños severos, NO USAR este producto fuera de los límites técnicos y sus aplicaciones.  
Las normas locales pueden regular el uso de este producto.



AQL PROTECCION

Carretera N-340 Km 1245, 3 Nave B-5 Polígono industrial El Pla 08750 Molins de Rei, Barcelona (España)  
Tel. (+34) 936800376 \* WhatsApp pedidos: 660781482 \* [www.aqlproteccion.com](http://www.aqlproteccion.com) \* [aql@aqlproteccion.com](mailto:aql@aqlproteccion.com)

ANBER

Avda. de las Flores, 13-15 P.E. El Molino 28970 Humanes de Madrid, Madrid (España)  
Tel. (+34) 916063711 \* WhatsApp pedidos: 649787619 \* [www.anber.es](http://www.anber.es) \* [anber@anber.es](mailto:anber@anber.es)

**130R**

Te 90° reducida H

**245**

Machón reducción M/M

**246**

Manguito reducción M/H

**240**

Manguito reducción H/H

**241**

Tuerca reducción M/H

**270**

Manguito H/H

**270L**

Manguito H/H extra largo 48mm

**280**

Machón M/M

**290**

Tapón rosca macho

**300**

Tapón hexagonal H

**301**

Tapón H

**312**

Tuerca hexagonal

**321**

Brida redonda con taladros H

**340**

Tuerca unión H/H asiento cónico

**341**

Tuerca unión M/H asiento cónico

**529**

Manguito M/H



REF: CA\_022023\_REV1



Para prevenir roturas, accidentes o daños severos, NO USAR este producto fuera de los límites técnicos y sus aplicaciones.  
Las normas locales pueden regular el uso de este producto.



AQL PROTECCION

Carretera N-340 Km 1245, 3 Nave B-5 Polígono industrial El Pla 08750 Molins de Rei, Barcelona (España)  
Tel. (+34) 936800376 \* WhatsApp pedidos: 660781482 \* [www.aqlproteccion.com](http://www.aqlproteccion.com) \* [aql@aqlproteccion.com](mailto:aql@aqlproteccion.com)

ANBER

Avda. de las Flores, 13-15 P.E. El Molino 28970 Humanes de Madrid, Madrid (España)  
Tel. (+34) 916063711 \* WhatsApp pedidos: 649787619 \* [www.anber.es](http://www.anber.es) \* [anber@anber.es](mailto:anber@anber.es)

**001**

Curva 90° M/H

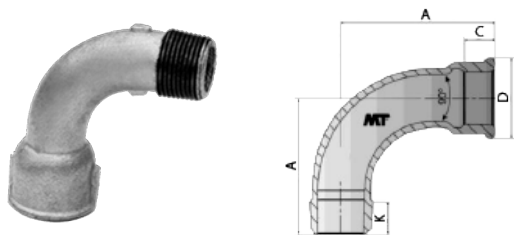

Código	Medida	Ud caja	A	C	K	D
001-010	3/8"	10	36	10	11	25
001-015	1/2"	10	45	13	15	29
001-020	3/4"	10	50	15	16	35,8
001-025	1"	10	63	17	19	43
001-032	1 1/4"	5	76	19	21	52,5
001-040	1 1/2"	5	85	19	21	59
001-050	2"	5	102	24	25	72,5
001-065	2 1/2"	1	115	27	30	90
001-080	3"	1	137	30	33	103,5
001-100	4"	1	167	36	40	133

**002**

Curva 90° H/H

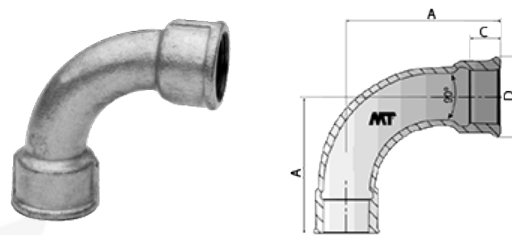

Código	Medida	Ud caja	A	C	D
002-010	3/8"	10	48	10	25
002-015	1/2"	10	55	13	29
002-020	3/4"	10	69	15	35,8
002-025	1"	10	85	17	43
002-032	1 1/4"	5	105	19	52,5
002-040	1 1/2"	5	116	19	59
002-050	2"	5	140	24	72,5
002-065	2 1/2"	1	176	27	89
002-080	3"	1	205	30	103,5
002-100	4"	1	260	36	130,5

**003**

Curva 90° M/M

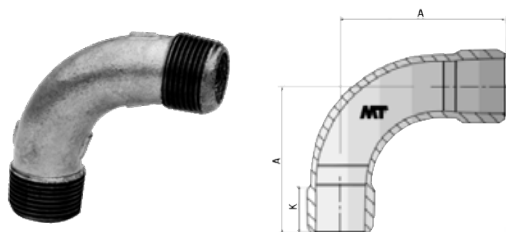

Código	Medida	Ud caja	A	K
003-015	1/2"	10	48	13
003-020	3/4"	10	60	15
003-025	1"	10	75	17
003-032	1 1/4"	5	95	19
003-040	1 1/2"	5	105	19
003-050	2"	5	130	24

**040**

Curva 45° M/H

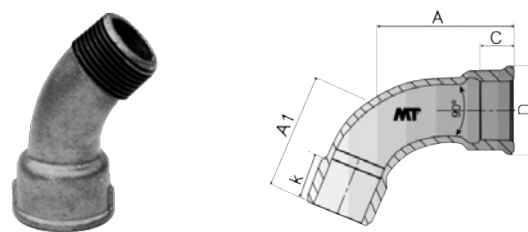

Código	Medida	Ud caja	A	A1	C	K	D
040-010	3/8"	10	30	24	10	11	25
040-015	1/2"	10	36	30	13	15	29
040-020	3/4"	10	43	36	15	16	35,8
040-025	1"	10	51	42	17	19	43
040-032	1 1/4"	5	64	54	19	21	52,5
040-040	1 1/2"	5	68	58	19	21	59
040-050	2"	5	81	70	24	25	72,5
040-065	2 1/2"	1	99	86	27	30	89
040-080	3"	1	113	100	30	33	103,5
040-100	4"	1	142	126	36	39	130,5

REF: CA\_022023\_REV1



Para prevenir roturas, accidentes o daños severos, NO USAR este producto fuera de los límites técnicos y sus aplicaciones.  
Las normas locales pueden regular el uso de este producto.



AQL PROTECCION

Carretera N-340 Km 1245, 3 Nave B-5 Polígono industrial El Pla 08750 Molins de Rei, Barcelona (España)  
Tel. (+34) 936800376 \* WhatsApp pedidos: 660781482 \* [www.aqlproteccion.com](http://www.aqlproteccion.com) \* [aql@aqlproteccion.com](mailto:aql@aqlproteccion.com)

ANBER

Avda. de las Flores, 13-15 P.E. El Molino 28970 Humanes de Madrid, Madrid (España)  
Tel. (+34) 916063711 \* WhatsApp pedidos: 649787619 \* [www.anber.es](http://www.anber.es) \* [anber@anber.es](mailto:anber@anber.es)

**041**

Curva 45° H/H

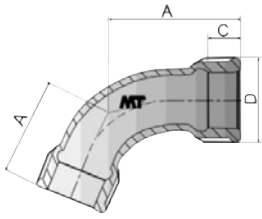

Código	Medida	Ud caja	A	C	D
041-015	1/2"	10	36	13	29
041-020	3/4"	10	43	15	35,8
041-025	1"	10	51	17	43
041-032	1 1/4"	5	64	19	52,5
041-040	1 1/2"	5	68	19	59
041-050	2"	5	81	24	71,5
041-065	2 1/2"	1	99	27	89
041-080	3"	1	113	30	103,5
041-100	4"	1	142	36	130,5

**085**

Curva puente H/H

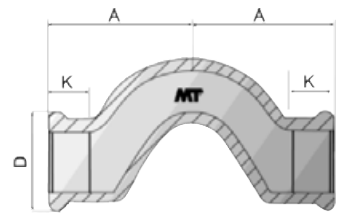

Código	Medida	Ud caja	A	D	K
085-015	1/2"	10	46	29	13
085-020	3/4"	10	56	35,8	15
085-025	1"	10	70	43	17

**090**

Codo 90° H/H

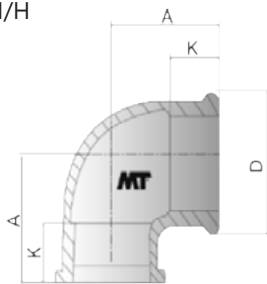

Código	Medida	Ud caja	A	D	K
090-008	1/4"	10	21	20	10
090-010	3/8"	10	25	25	10
090-015	1/2"	10	28	29	13
090-020	3/4"	10	33	35	15
090-025	1"	10	38	43	17
090-032	1 1/4"	5	45	52,5	19
090-040	1 1/2"	5	50	59	19
090-050	2"	5	58	72,5	24
090-065	2 1/2"	1	69	89	27
090-080	3"	1	78	103,5	30
090-100	4"	1	96	130,5	36

**092**

Codo 90° M/H

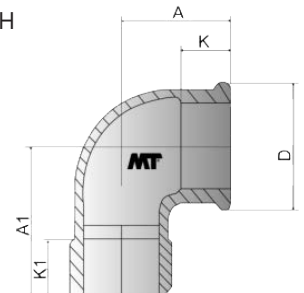

Código	Medida	Ud caja	A	A1	D	K	K1
092-008	1/4"	10	21	28	20	10	7,5
092-010	3/8"	10	25	32	25	10	11
092-015	1/2"	10	28	37	29	13	15
092-020	3/4"	10	33	43	35,8	15	16
092-025	1"	10	38	52	43	17	19
092-032	1 1/4"	5	45	60	52,5	19	21
092-040	1 1/2"	5	50	65	59	19	21
092-050	2"	5	58	74	72,5	24	25
092-065	2 1/2"	1	69	88	89	27	30
092-080	3"	1	78	98	103,5	30	33
092-100	4"	1	96	118	130,5	36	39

REF: CA\_022023\_REV1



Para prevenir roturas, accidentes o daños severos, NO USAR este producto fuera de los límites técnicos y sus aplicaciones.  
Las normas locales pueden regular el uso de este producto.



AQL PROTECCION

Carretera N-340 Km 1245, 3 Nave B-5 Polígono industrial El Pla 08750 Molins de Rei, Barcelona (España)  
Tel. (+34) 936800376 \* WhatsApp pedidos: 660781482 \* [www.aqlproteccion.com](http://www.aqlproteccion.com) \* [aql@aqlproteccion.com](mailto:aql@aqlproteccion.com)

ANBER

Avda. de las Flores, 13-15 P.E. El Molino 28970 Humanes de Madrid, Madrid (España)  
Tel. (+34) 916063711 \* WhatsApp pedidos: 649787619 \* [www.anber.es](http://www.anber.es) \* [anber@anber.es](mailto:anber@anber.es)

## 090R

Codo 90° reducido H/H

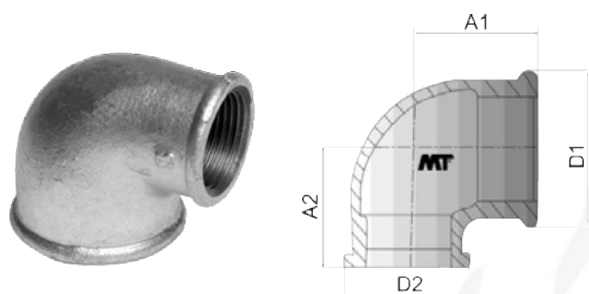

Código	Medida	Ud caja	A1	A2	D1	D2
090-01510	1/2" x 3/8"	10	26	26	29	25
090-02015	3/4" x 1/2"	10	30	31	35	29
090-02515	1" x 1/2"	10	32	34	43	29
090-02520	1" x 3/4"	10	35	36	43	35,8
090-03215	1 1/4" x 1/2"	5	35	38	52,5	29
090-03220	1 1/4" x 3/4"	5	36	41	52,5	35,8
090-03225	1 1/4" x 1"	5	40	42	52,5	43
090-04015	1 1/2" x 1/2"	5	36	42	60	29,6
090-04020	1 1/2" x 3/4"	5	42	46	59	35,8
090-04025	1 1/2" x 1"	5	42	46	59	43
090-04032	1 1/2" x 1 1/4"	5	46	48	60	53
090-05015	2" x 1/2"	5	38	48	73	29,6
090-05020	2" x 3/4"	5	40	50	72,5	35,8
090-05025	2" x 1"	5	44	52	72,5	43
090-05032	2" x 1 1/4"	5	48	53	72,5	52,5
090-05040	2" x 1 1/2"	5	52	55	73	60
090-06540	2 1/2" x 1 1/2"	1	55	63	89	59
090-06550	2 1/2" x 2"	1	61	66	89	72,5
090-08050	3" x 2"	1	73	78	105	73
090-08065	3" x 2 1/2"	1	72	76	103,5	89

## 096

Codo unión H/H asiento cónico

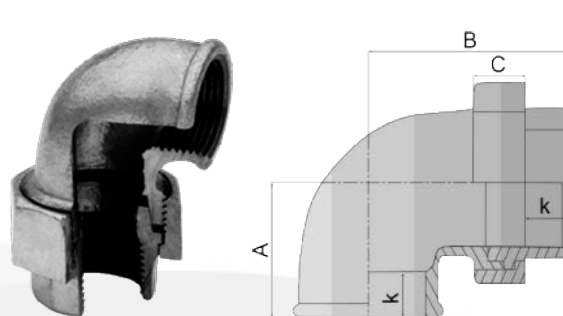

Código	Medida	Ud caja	A	B	C	K
096-010	3/8"	10	23	53	17	11
096-015	1/2"	10	28	58	18	13
096-020	3/4"	10	33	62	20	15
096-025	1"	10	38	72	22	17
096-032	1 1/4"	5	45	82	24	19
096-040	1 1/2"	5	50	90	25	19
096-050	2"	1	58	100	27	24

Roscas sujeción s/ISO 228/1 (DIN 259).

## 098

Codo unión M/H asiento cónico

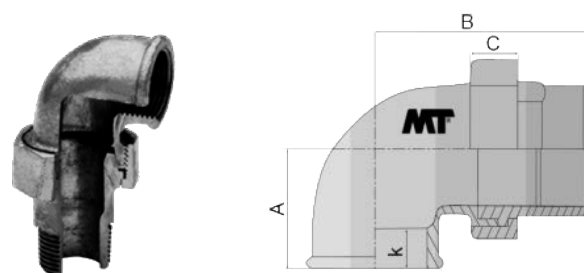

Código	Medida	Ud caja	A	B	C	K
098-010	3/8"	10	24	63	17	11
098-015	1/2"	10	28	76	18	13
098-020	3/4"	10	33	82	20	15
098-025	1"	10	38	94	22	17
098-032	1 1/4"	5	45	107	24	19
098-040	1 1/2"	5	50	115	25	19
098-050	2"	1	58	128	27	24
098-065	2 1/2"	1	78	156	30	27

Roscas sujeción s/ISO 228/1 (DIN 259).

REF: CA\_022023\_REV1



Para prevenir roturas, accidentes o daños severos, NO USAR este producto fuera de los límites técnicos y sus aplicaciones. Las normas locales pueden regular el uso de este producto.



AQL PROTECCION

Carretera N-340 Km 1245, 3 Nave B-5 Polígono industrial El Pla 08750 Molins de Rei, Barcelona (España)  
Tel. (+34) 936800376 \* WhatsApp pedidos: 660781482 \* [www.aqlproteccion.com](http://www.aqlproteccion.com) \* [aql@aqlproteccion.com](mailto:aql@aqlproteccion.com)

ANBER

Avda. de las Flores, 13-15 P.E. El Molino 28970 Humanes de Madrid, Madrid (España)  
Tel. (+34) 916063711 \* WhatsApp pedidos: 649787619 \* [www.anber.es](http://www.anber.es) \* [anber@anber.es](mailto:anber@anber.es)

**120**

Codo 45° H/H

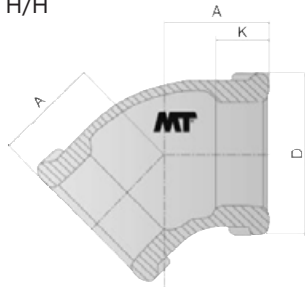

Código	Medida	Ud caja	A	D	K
120-015	1/2"	10	22	29	13
120-020	3/4"	10	25	36	15
120-025	1"	10	28	43	17
120-032	1 1/4"	5	33	52	19
120-040	1 1/2"	5	36	59	19
120-050	2"	5	43	72	24
120-065	2 1/2"	1	49	89	27
120-080	3"	1	55	103	30
120-100	4"	1	66	130	36

**180**

Cruz 90° H

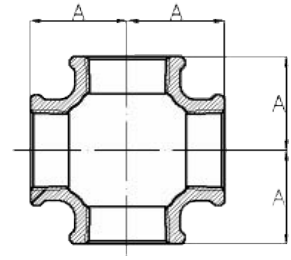

Código	Medida	Ud caja	A
180-010	3/8"	10	25,5
180-015	1/2"	10	28
180-020	3/4"	10	33
180-025	1"	10	38
180-032	1 1/4"	5	45
180-040	1 1/2"	5	50
180-050	2"	5	58
180-065	2 1/2"	1	69
180-080	3"	1	78
180-100	4"	1	96

**221**

Codo 3 bocas H

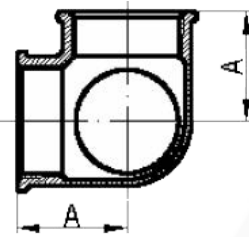

Código	Medida	Ud caja	A
221-015	1/2"	10	28
221-020	3/4"	10	33
221-025	1"	10	38
221-040	1 1/2"	5	50

**223**

Codo 4 bocas H

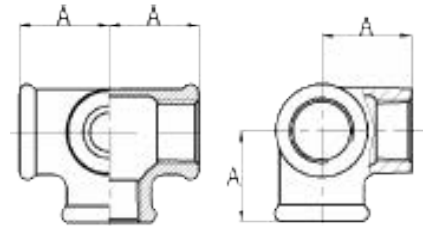

Código	Medida	Ud caja	A
223-015	1/2"	10	28
223-020	3/4"	10	33
223-025	1"	10	38

REF: CA\_022023\_REV1



Para prevenir roturas, accidentes o daños severos, NO USAR este producto fuera de los límites técnicos y sus aplicaciones.  
Las normas locales pueden regular el uso de este producto.



AQL PROTECCION

Carretera N-340 Km 1245, 3 Nave B-5 Polígono industrial El Pla 08750 Molins de Rei, Barcelona (España)  
Tel. (+34) 936800376 \* WhatsApp pedidos: 660781482 \* [www.aqlproteccion.com](http://www.aqlproteccion.com) \* [aql@aqlproteccion.com](mailto:aql@aqlproteccion.com)

ANBER

Avda. de las Flores, 13-15 P.E. El Molino 28970 Humanes de Madrid, Madrid (España)  
Tel. (+34) 916063711 \* WhatsApp pedidos: 649787619 \* [www.anber.es](http://www.anber.es) \* [anber@anber.es](mailto:anber@anber.es)

**130**

Te 90° igual H

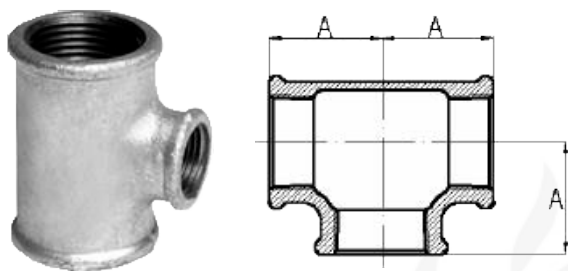
**130R**

Te 90° reducida H

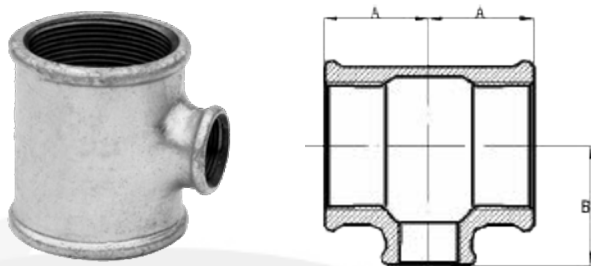

Código	Medida	Ud caja	A
130-008	1/4" *	10	21
130-010	3/8" *	10	25
130-015	1/2"	10	28
130-020	3/4"	10	33
130-025	1"	10	38
130-032	1 1/4"	5	45
130-040	1 1/2"	5	50
130-050	2"	5	58
130-065	2 1/2"	1	69
130-080	3"	1	78
130-100	4"	1	96

\* No aprobada por FM.

Código	Medida	Ud caja	A	B
130-02015	3/4" x 1/2"	10	30	31
130-02515	1" x 1/2"	10	32	34
130-02520	1" x 3/4"	10	35	36
130-03215	1 1/4" x 1/2"	5	34	38
130-03220	1 1/4" x 3/4"	5	36	41
130-03225	1 1/4" x 1"	5	40	42
130-04015	1 1/2" x 1/2"	5	36	42
130-04020	1 1/2" x 3/4"	5	38	44
130-04025	1 1/2" x 1"	5	42	46
130-04032	1 1/2" x 1 1/4"	5	46	48
130-05015	2" x 1/2"	5	38	48
130-05020	2" x 3/4"	5	40	50
130-05025	2" x 1"	5	44	52
130-05032	2" x 1 1/4"	5	48	54
130-05040	2" x 1 1/2"	5	52	55
130-06520	2 1/2" x 3/4"	1	49	58
130-06525	2 1/2" x 1"	1	47	60
130-06532	2 1/2" x 1 1/4"	1	52	62
130-06540	2 1/2" x 1 1/2"	1	55	63
130-06550	2 1/2" x 2"	1	61	66
130-08040	3" x 1 1/2"	1	58	71
130-08050	3" x 2"	1	64	73
130-08065	3" x 2 1/2"	1	72	76
130-10050	4" x 2"	1	70	86
130-10065	4" x 2 1/2"	1	78	90
130-10080	4" x 3"	1	84	92

REF: CA\_022023\_REV1



Para prevenir roturas, accidentes o daños severos, NO USAR este producto fuera de los límites técnicos y sus aplicaciones.  
Las normas locales pueden regular el uso de este producto.



## AQL PROTECCION

Carretera N-340 Km 1245, 3 Nave B-5 Polígono industrial El Pla 08750 Molins de Rei, Barcelona (España)  
Tel. (+34) 936800376 \* WhatsApp pedidos: 660781482 \* [www.aqlproteccion.com](http://www.aqlproteccion.com) \* [aql@aqlproteccion.com](mailto:aql@aqlproteccion.com)

## ANBER

Avda. de las Flores, 13-15 P.E. El Molino 28970 Humanes de Madrid, Madrid (España)  
Tel. (+34) 916063711 \* WhatsApp pedidos: 649787619 \* [www.anber.es](http://www.anber.es) \* [anber@anber.es](mailto:anber@anber.es)



245

Machón reducción M/M

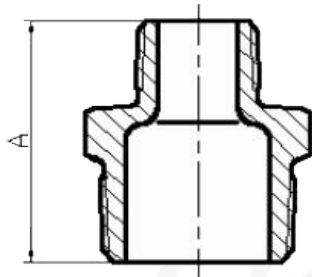

246

Manguito reducción M/H

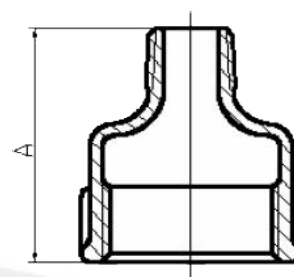

Código	Medida	Ud caja	A
245-01008	3/8" x 1/4"	10	39
245-01508	1/2" x 1/4"	10	44
245-01510	1/2" x 3/8"	10	44
245-02010	3/4" x 3/8"	10	47
245-02015	3/4" x 1/2"	10	47
245-02515	1" x 1/2"	10	53
245-02520	1" x 3/4"	10	53
245-03215	1 1/4" x 1/2"	5	57
245-03220	1 1/4" x 3/4"	5	57
245-03225	1 1/4" x 1"	5	57
245-04020	1 1/2" x 3/4"	5	59
245-04025	1 1/2" x 1"	5	59
245-04032	1 1/2" x 1 1/4"	5	59
245-05025	2" x 1"	5	68
245-05032	2" x 1 1/4"	5	68
245-05040	2" x 1 1/2"	5	68
245-06540	2 1/2" x 1 1/2"	1	75
245-06550	2 1/2" x 2"	1	75
245-08050	3" x 2"	1	83
245-08065	3" x 2 1/2"	1	83
245-10080	4" x 3"	1	89

Código	Medida	Ud caja	A
246-01008	3/8" x 1/4"	10	35
246-01508	1/2" x 1/4"	10	43
246-01510	1/2" x 3/8"	10	43
246-02010	3/4" x 3/8"	10	48
246-02015	3/4" x 1/2"	10	48
246-02515	1" x 1/2"	10	55
246-02520	1" x 3/4"	10	55
246-03215	1 1/4" x 1/2"	5	60
246-03220	1 1/4" x 3/4"	5	60
246-03225	1 1/4" x 1"	5	60
246-04020	1 1/2" x 3/4"	5	63
246-04025	1 1/2" x 1"	5	63
246-04032	1 1/2" x 1 1/4"	5	63
246-05025	2" x 1"	5	70
246-05032	2" x 1 1/4"	5	70
246-05040	2" x 1 1/2"	5	70

REF: CA\_022023\_REV1



Para prevenir roturas, accidentes o daños severos, NO USAR este producto fuera de los límites técnicos y sus aplicaciones.  
Las normas locales pueden regular el uso de este producto.



AQL PROTECCION

Carretera N-340 Km 1245, 3 Nave B-5 Polígono industrial El Pla 08750 Molins de Rei, Barcelona (España)  
Tel. (+34) 936800376 \* WhatsApp pedidos: 660781482 \* [www.aqlproteccion.com](http://www.aqlproteccion.com) \* [aql@aqlproteccion.com](mailto:aql@aqlproteccion.com)

ANBER

Avda. de las Flores, 13-15 P.E. El Molino 28970 Humanes de Madrid, Madrid (España)  
Tel. (+34) 916063711 \* WhatsApp pedidos: 649787619 \* [www.anber.es](http://www.anber.es) \* [anber@anber.es](mailto:anber@anber.es)

240

Manguito reducción H/H

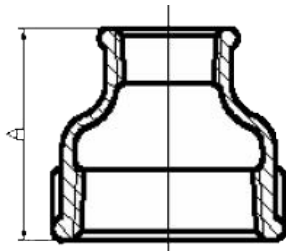

Código	Medida	Ud caja	A
240-01008	3/8" x 1/4"	10	30
240-01508	1/2" x 1/4"	10	36
240-01510	1/2" x 3/8"	10	36
240-02010	3/4" x 3/8"	10	39
240-02015	3/4" x 1/2"	10	39
240-02515	1" x 1/2"	10	45
240-02520	1" x 3/4"	10	45
240-03215	1 1/4" x 1/2"	5	50
240-03220	1 1/4" x 3/4"	5	50
240-03225	1 1/4" x 1"	5	50
240-04015	1 1/2" x 1/2"	5	55
240-04020	1 1/2" x 3/4"	5	55
240-04025	1 1/2" x 1"	5	55
240-04032	1 1/2" x 1 1/4"	5	55
240-05015	2" x 1/2"	5	65
240-05020	2" x 3/4"	5	65
240-05025	2" x 1"	5	65
240-05032	2" x 1 1/4"	5	65
240-05040	2" x 1 1/2"	5	65
240-06515	2 1/2" x 1/2"	1	74
240-06525	2 1/2" x 1"	1	74
240-06532	2 1/2" x 1 1/4"	1	74
240-06540	2 1/2" x 1 1/2"	1	74
240-06550	2 1/2" x 2"	1	74
240-08040	3" x 1 1/2"	1	80
240-08050	3" x 2"	1	80
240-08065	3" x 2 1/2"	1	80
240-10050	4" x 2"	1	94
240-10065	4" x 2 1/2"	1	94
240-10080	4" x 3"	1	94

241

Tuerca reducción M/H

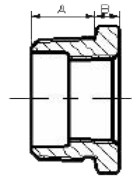
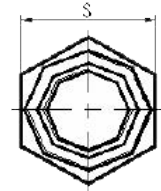

Código	Medida	Ud caja	A	B	S
241-01008	3/8" x 1/4"	10	12,2	4,1	17,3
241-01508	1/2" x 1/4"	10	14,2	4,8	22,1
241-01510	1/2" x 3/8"	10	14,2	4,8	22,1
241-02008	3/4" x 1/4"	10	16	5,6	29,2
241-02010	3/4" x 3/8"	10	16	5,6	29,2
241-02015	3/4" x 1/2"	10	16	5,6	29,2
241-02508	1" x 1/4"	10	24	7	35
241-02510	1" x 3/8"	10	21	7	35
241-02515	1" x 1/2"	10	19,1	6,4	36,1
241-02520	1" x 3/4"	10	19,1	6,4	36,1
241-03215	1 1/4" x 1/2"	5	24	8	45
241-03220	1 1/4" x 3/4"	5	20,3	7,1	44,7
241-03225	1 1/4" x 1"	5	20,3	7,1	44,7
241-04010	1 1/2" x 3/8"	5	24	8	49
241-04015	1 1/2" x 1/2"	5	22	9	50
241-04020	1 1/2" x 3/4"	5	22	9	50
241-04025	1 1/2" x 1"	5	21,1	7,9	50,8
241-04032	1 1/2" x 1 1/4"	5	21,1	7,9	50,8
241-05015	2" x 1/2" *	5	39	9	64
241-05020	2" x 3/4" *	5	39	9	64
241-05025	2" x 1"	5	26	9	63,2
241-05032	2" x 1 1/4"	5	22,4	8,6	63
241-05040	2" x 1 1/2"	5	22,4	8,6	63
241-06515	2 1/2" x 1/2"	5	29	11	80
241-06520	2 1/2" x 3/4"	5	29	11	80
241-06525	2 1/2" x 1" *	1	43	11	79
241-06532	2 1/2" x 1 1/4" *	1	43	11	79
241-06540	2 1/2" x 1 1/2"	1	29	11	79
241-06550	2 1/2" x 2"	1	29	11	79
241-08025	3" x 1" *	1	47	12	94
241-08032	3" x 1 1/4" *	1	47	12	94
241-08040	3" x 1 1/2" *	1	47	12	94
241-08050	3" x 2"	1	32	12	94
241-08065	3" x 2 1/2"	1	47	12	94
241-10050	4" x 2"	1	55	14	119
241-10065	4" x 2 1/2" *	1	55	14	119
241-10080	4" x 3"	1	55	14	119

\* No aprobada por FM.

REF: CA\_022023\_REV1



Para prevenir roturas, accidentes o daños severos, NO USAR este producto fuera de los límites técnicos y sus aplicaciones.  
Las normas locales pueden regular el uso de este producto.



AQL PROTECCION

Carretera N-340 Km 1245, 3 Nave B-5 Polígono industrial El Pla 08750 Molins de Rei, Barcelona (España)  
Tel. (+34) 936800376 \* WhatsApp pedidos: 660781482 \* [www.aqlproteccion.com](http://www.aqlproteccion.com) \* [aql@aqlproteccion.com](mailto:aql@aqlproteccion.com)

ANBER

Avda. de las Flores, 13-15 P.E. El Molino 28970 Humanes de Madrid, Madrid (España)  
Tel. (+34) 916063711 \* WhatsApp pedidos: 649787619 \* [www.anber.es](http://www.anber.es) \* [anber@anber.es](mailto:anber@anber.es)

**270**

Manguito H/H

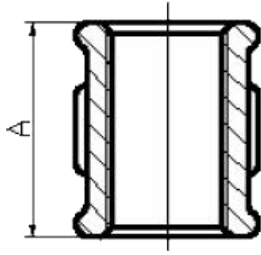

Código	Medida	Ud caja	A
270-008	1/4" *	10	27
270-010	3/8" *	10	30
270-015	1/2"	10	36
270-020	3/4"	10	39
270-025	1"	10	45
270-032	1 1/4"	5	50
270-040	1 1/2"	5	55
270-050	2"	5	65
270-065	2 1/2"	1	74
270-080	3"	1	80
270-100	4"	1	94

\* No aprobada por FM.

**280**

Machón M/M

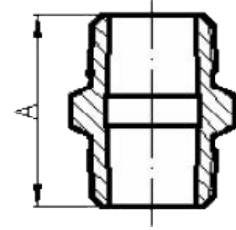

Código	Medida	Ud caja	A
280-008	1/4"	10	36
280-010	3/8"	10	38
280-015	1/2"	10	43
280-020	3/4"	10	45
280-025	1"	10	52
280-032	1 1/4"	5	56
280-040	1 1/2"	5	40
280-050	2"	5	50
280-065	2 1/2"	1	65
280-080	3"	1	80
280-100	4"	1	100

**290**

Tapón rosca macho

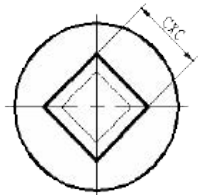
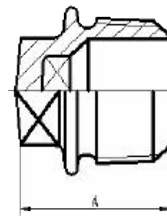

Código	Medida	Ud caja	A	C
290-008	1/4"	10	22	8
290-010	3/8"	10	24	10
290-015	1/2"	10	26	11
290-020	3/4"	10	32	17
290-025	1"	10	36	19
290-032	1 1/4"	5	39	22
290-040	1 1/2"	5	41	22
290-050	2"	5	48	27
290-065	2 1/2"	1	54	32
290-080	3"	1	60	36
290-100	4"	1	70	41

**270L**

Manguito H/H extra largo 48mm

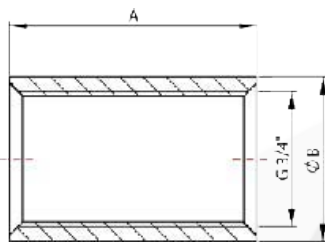

Código	Medida	Ud caja	A	B
270-020L	3/4"	10	48	32

REF: CA\_022023\_REV1



Para prevenir roturas, accidentes o daños severos, NO USAR este producto fuera de los límites técnicos y sus aplicaciones.  
Las normas locales pueden regular el uso de este producto.



AQL PROTECCION

Carretera N-340 Km 1245, 3 Nave B-5 Polígono industrial El Pla 08750 Molins de Rei, Barcelona (España)  
Tel. (+34) 936800376 \* WhatsApp pedidos: 660781482 \* [www.aqlproteccion.com](http://www.aqlproteccion.com) \* [aql@aqlproteccion.com](mailto:aql@aqlproteccion.com)

ANBER

Avda. de las Flores, 13-15 P.E. El Molino 28970 Humanes de Madrid, Madrid (España)  
Tel. (+34) 916063711 \* WhatsApp pedidos: 649787619 \* [www.anber.es](http://www.anber.es) \* [anber@anber.es](mailto:anber@anber.es)

**300**

Tapón hexagonal H

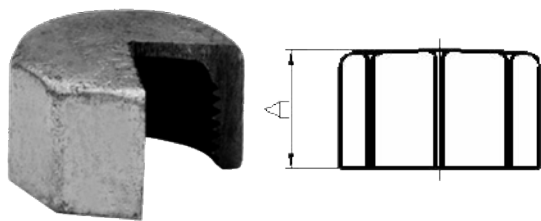

Código	Medida	Ud caja	A
300-008	1/4"	10	15
300-010	3/8"	10	18
300-015	1/2"	10	20
300-020	3/4"	10	23
300-025	1"	10	25
300-032	1 1/4"	5	28
300-040	1 1/2"	5	28
300-050	2"	5	33
300-065	2 1/2"	1	36,5
300-080	3"	1	38
300-100	4"	1	46,5

**301**

Tapón H

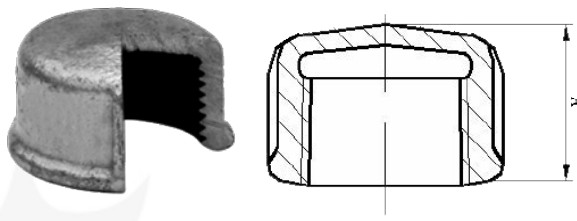

Código	Medida	Ud caja	A
301-010	3/8"	10	17
301-015	1/2"	10	19
301-020	3/4"	10	22
301-025	1"	10	25
301-032	1 1/4"	5	28
301-040	1 1/2"	5	31
301-050	2"	5	35
301-065	2 1/2"	1	38
301-080	3"	1	40
301-100	4"	1	50

**312**

Tuerca hexagonal

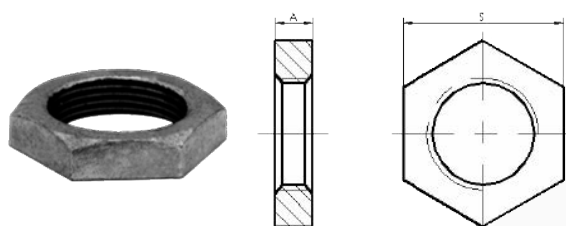

Código	Medida	Ud caja	A	S
312-010	3/8"	10	7	27
312-015	1/2"	10	8	32
312-020	3/4"	10	9	36
312-025	1"	10	10	46
312-032	1 1/4"	5	11	55
312-040	1 1/2"	5	12	60
312-050	2"	5	13	75

**321**

Brida redonda con taladros H

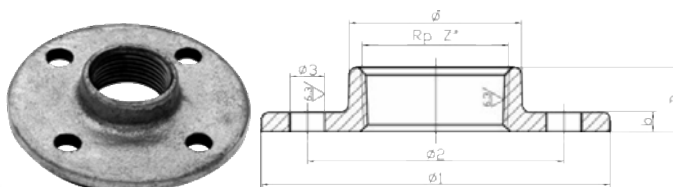

Código	Medida	Ud caja	Ø	Ø1	Ø2	Ø3	b	B
321-015	1/2"	10	26	80	55	11	5	15
321-020	3/4"	10	32	90	65	11	5	16
321-025	1"	10	39	100	75	11	6	19
321-032	1 1/4"	5	49	120	90	14	6	21
321-040	1 1/2"	5	55	130	100	14	7	21
321-050	2"	5	69	140	110	14	8	26
321-065	2 1/2"	1	84	160	130	14	9	30
321-080	3"	1	98	190	150	18	10	33
321-100	4"	1	124	210	170	18	11	39

Dimensiones de Brida según EN-1092 PN6.

REF: CA\_022023\_REV1



Para prevenir roturas, accidentes o daños severos, NO USAR este producto fuera de los límites técnicos y sus aplicaciones.  
Las normas locales pueden regular el uso de este producto.



AQL PROTECCION

Carretera N-340 Km 1245, 3 Nave B-5 Polígono industrial El Pla 08750 Molins de Rei, Barcelona (España)  
Tel. (+34) 936800376 \* WhatsApp pedidos: 660781482 \* [www.aqlproteccion.com](http://www.aqlproteccion.com) \* [aql@aqlproteccion.com](mailto:aql@aqlproteccion.com)

ANBER

Avda. de las Flores, 13-15 P.E. El Molino 28970 Humanes de Madrid, Madrid (España)  
Tel. (+34) 916063711 \* WhatsApp pedidos: 649787619 \* [www.anber.es](http://www.anber.es) \* [anber@anber.es](mailto:anber@anber.es)

**340**

Tuerca unión H/H asiento cónico

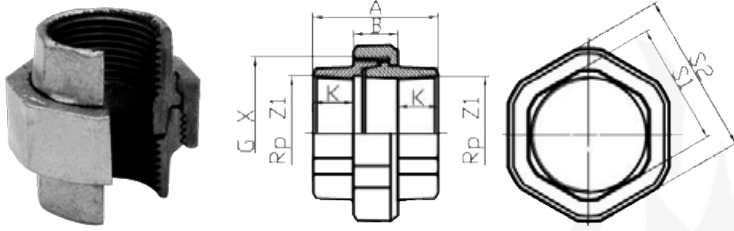

Código	Medida	Ud caja	A	B	S1	S2 max	K	X
340-008	1/4"	10	42	16,5	19	33	10	3/4"
340-010	3/8"	10	45	17	21	36	10	7/8"
340-015	1/2"	10	48	19	25	44	13	1 1/8"
340-020	3/4"	10	52	20	31	50	15	1 1/4"
340-025	1"	10	58	22	38	55	17	1 1/2"
340-032	1 1/4"	5	65	23,5	48	70	19	2"
340-040	1 1/2"	5	70	25,5	53,5	75	19	2 1/4"
340-050	2"	5	78	27	66	90	24	2 3/4"
340-065	2 1/2"	1	85	30	84	110	27	3 1/2"
340-080	3"	1	95	31	96,5	130	30	4"
340-100	4"	1	110	36	125	150	36	5"

Roscas sujeción s/ ISO 228/1 (DIN 259).

**341**

Tuerca unión M/H asiento cónico

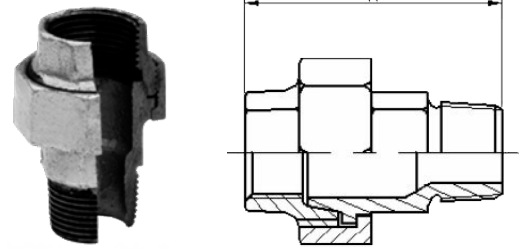

Código	Medida	Ud caja	A
341-008	1/4"	10	55
341-010	3/8"	10	58
341-015	1/2"	10	66
341-020	3/4"	10	72
341-025	1"	10	80
341-032	1 1/4"	5	90
341-040	1 1/2"	5	95
341-050	2"	5	106
341-065	2 1/2"	1	118
341-080	3"	1	126
301-100	4"	1	133

Roscas sujeción s/ ISO 228/1 (DIN 259).

**529**

Manguito M/H

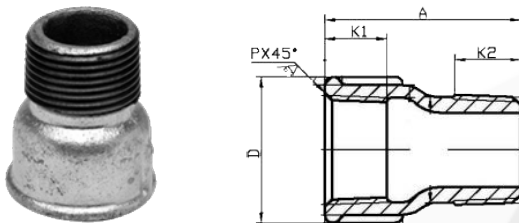

Código	Medida	Ud caja	A	D	K1	K2
529-015	1/2"	10	43	29	13	15
529-020	3/4"	10	48	35,8	15	16
529-025	1"	10	55	43	17	19
529-032	1 1/4"	5	60	52,5	19	21
529-040	1 1/2"	5	63	59	19	21
529-050	2"	5	70	72,5	24	25

REF: CA\_022023\_REV1



Para prevenir roturas, accidentes o daños severos, NO USAR este producto fuera de los límites técnicos y sus aplicaciones.  
Las normas locales pueden regular el uso de este producto.



AQL PROTECCION

Carretera N-340 Km 1245, 3 Nave B-5 Polígono industrial El Pla 08750 Molins de Rei, Barcelona (España)  
Tel. (+34) 936800376 \* WhatsApp pedidos: 660781482 \* [www.aqlproteccion.com](http://www.aqlproteccion.com) \* [aql@aqlproteccion.com](mailto:aql@aqlproteccion.com)

ANBER

Avda. de las Flores, 13-15 P.E. El Molino 28970 Humanes de Madrid, Madrid (España)  
Tel. (+34) 916063711 \* WhatsApp pedidos: 649787619 \* [www.anber.es](http://www.anber.es) \* [anber@anber.es](mailto:anber@anber.es)

